

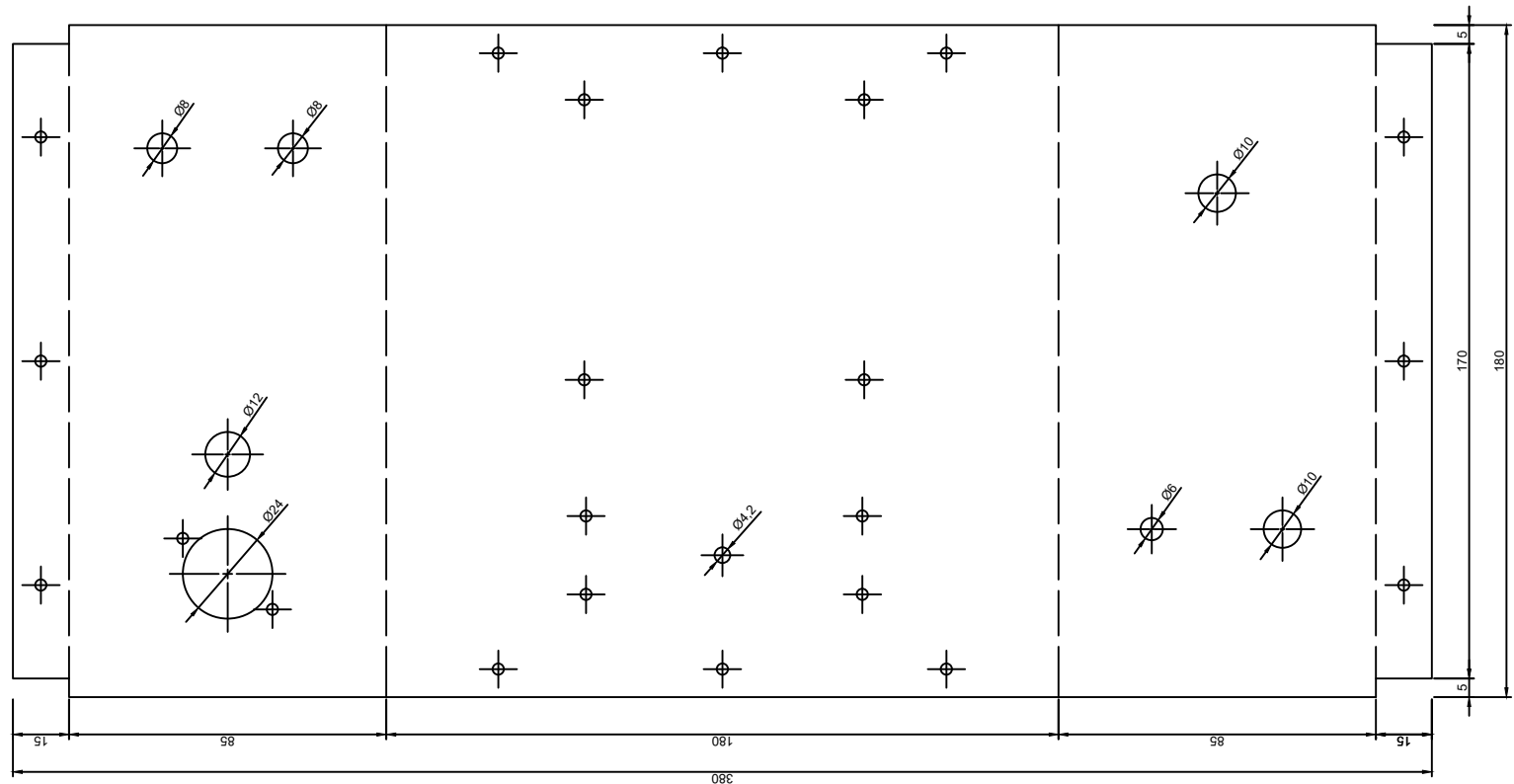

Drawn by Nathan Campos		Project Name Bipolar Enclosure		
		Title Overview		
		Rev A	Scale 1:2	Date 2020-12-11

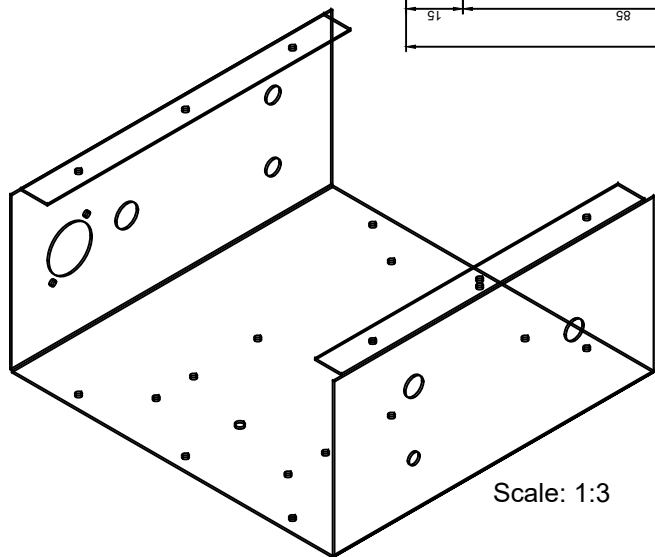

All unmarked holes are 3mm in diameter.



Drawn by <b>Nathan Campos</b>		Project Name <b>Bipolar Enclosure</b>		
		Title <b>Base Plate</b>		
		Rev <b>A</b>	Scale <b>1:2</b>	Date <b>2020-12-11</b>

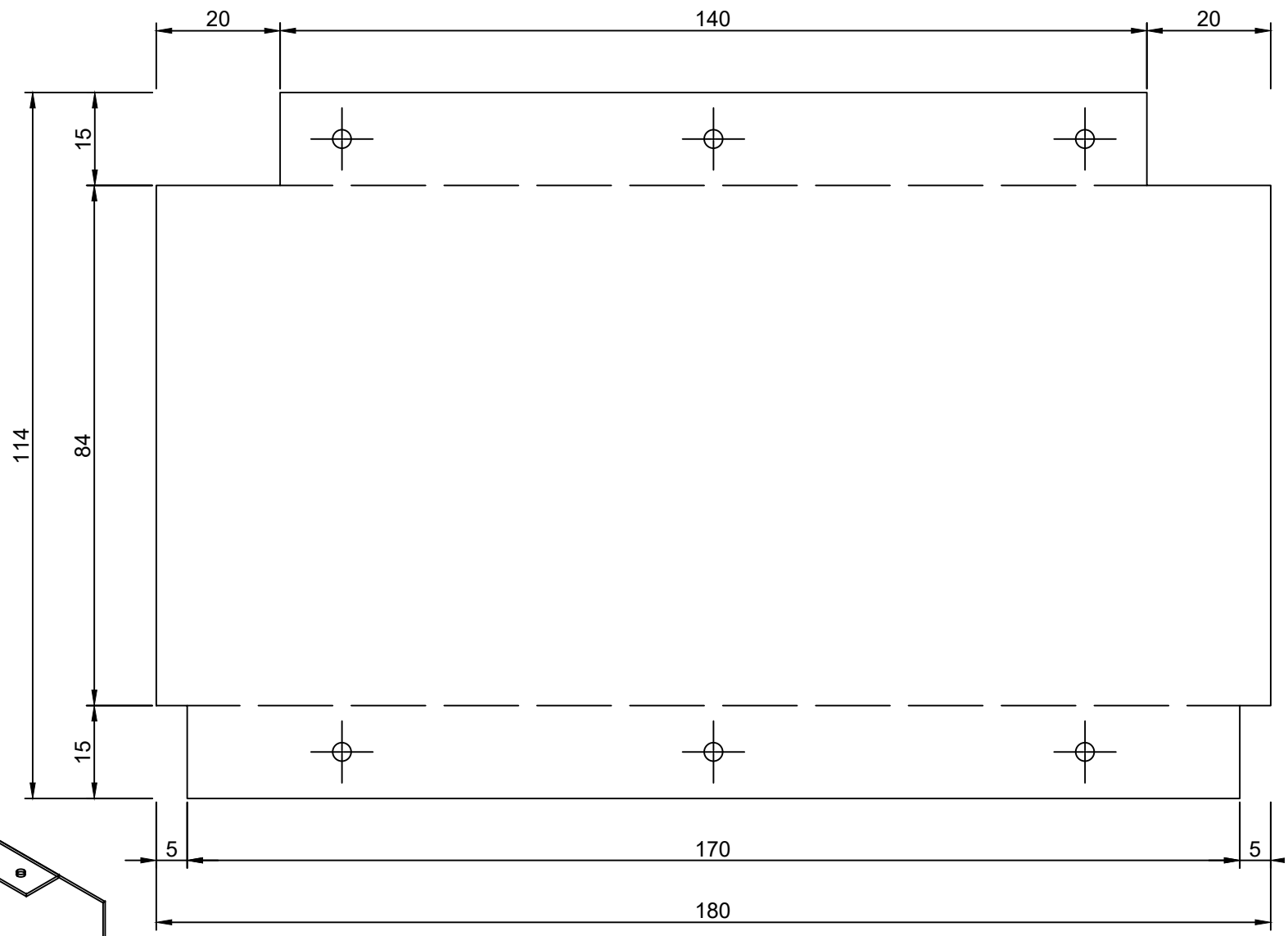

All unmarked holes are 3mm in diameter.

Scale: 1:2

Drawn by <b>Nathan Campos</b>		Project Name <b>Bipolar Enclosure</b>	
		Title <b>Side Plates</b>	
		Rev <b>A</b>	Scale <b>1:1</b>

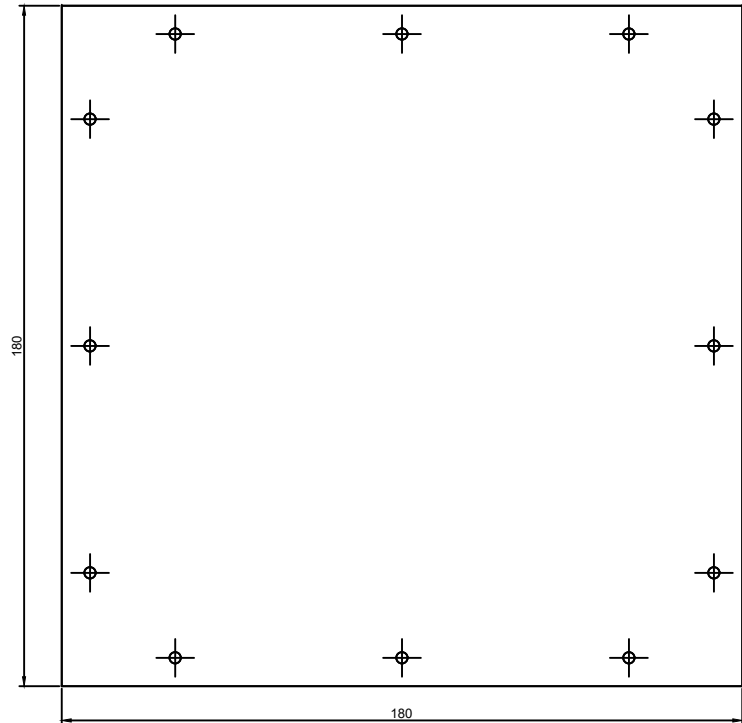

Drawn by <b>Nathan Campos</b>		Project Name <b>Bipolar Enclosure</b>	
		Title <b>Top Plate</b>	
		Rev <b>A</b>	Scale <b>1:2</b>